

INTERNATIONAL STANDARD

ISO 20502

First edition
2005-08-15

Fine ceramics (advanced ceramics, advanced technical ceramics) — Determination of adhesion of ceramic coatings by scratch testing

*Céramiques techniques — Détermination de l'adhérence
des revêtements céramiques par essai de rayure*



Reference number
ISO 20502:2005(E)

© ISO 2005

PDF disclaimer

This PDF file may contain embedded typefaces. In accordance with Adobe's licensing policy, this file may be printed or viewed but shall not be edited unless the typefaces which are embedded are licensed to and installed on the computer performing the editing. In downloading this file, parties accept therein the responsibility of not infringing Adobe's licensing policy. The ISO Central Secretariat accepts no liability in this area.

Adobe is a trademark of Adobe Systems Incorporated.

Details of the software products used to create this PDF file can be found in the General Info relative to the file; the PDF-creation parameters were optimized for printing. Every care has been taken to ensure that the file is suitable for use by ISO member bodies. In the unlikely event that a problem relating to it is found, please inform the Central Secretariat at the address given below.

© ISO 2005

All rights reserved. Unless otherwise specified, no part of this publication may be reproduced or utilized in any form or by any means, electronic or mechanical, including photocopying and microfilm, without permission in writing from either ISO at the address below or ISO's member body in the country of the requester.

ISO copyright office
Case postale 56 • CH-1211 Geneva 20
Tel. + 41 22 749 01 11
Fax + 41 22 749 09 47
E-mail copyright@iso.org
Web www.iso.org

Published in Switzerland

Contents

Page

Foreword.....	iv
1 Scope	1
2 Normative references	1
3 Principle	1
4 Apparatus and materials	2
4.1 Scratch tester	2
4.2 Diamond stylus	2
5 Preparation of test piece	3
5.1 General requirements	3
5.2 Surface roughness, waviness and levelling	3
5.3 Specimen cleaning	3
5.4 Coating-substrate parameters relevant to a test	4
6 Test procedure	4
6.1 General	4
6.2 Equipment preparation	4
6.3 Environmental conditions	5
6.4 Scratching procedure	5
6.4.1 General	5
6.4.2 Progressive-force scratch test	5
6.4.3 Constant-force scratch test	5
6.4.4 Multi-pass scratch test	5
6.5 Scratch evaluation and critical normal-force determination	6
6.5.1 General	6
6.5.2 Microscope observation	6
6.5.3 Acoustic emission (AE) and frictional force (FF) recording	6
7 Repeatability and limits	7
8 Test report	7
Annex A (normative) Procedure for calibration of a scratch testing system	12
Annex B (informative) Typical failure modes obtained in scratch testing	19
Bibliography	31

Foreword

ISO (the International Organization for Standardization) is a worldwide federation of national standards bodies (ISO member bodies). The work of preparing International Standards is normally carried out through ISO technical committees. Each member body interested in a subject for which a technical committee has been established has the right to be represented on that committee. International organizations, governmental and non-governmental, in liaison with ISO, also take part in the work. ISO collaborates closely with the International Electrotechnical Commission (IEC) on all matters of electrotechnical standardization.

International Standards are drafted in accordance with the rules given in the ISO/IEC Directives, Part 2.

The main task of technical committees is to prepare International Standards. Draft International Standards adopted by the technical committees are circulated to the member bodies for voting. Publication as an International Standard requires approval by at least 75 % of the member bodies casting a vote.

Attention is drawn to the possibility that some of the elements of this document may be the subject of patent rights. ISO shall not be held responsible for identifying any or all such patent rights.

ISO 20502 was prepared by Technical Committee ISO/TC 206, *Fine ceramics*.

Fine ceramics (advanced ceramics, advanced technical ceramics) — Determination of adhesion of ceramic coatings by scratch testing

1 Scope

This International Standard describes a method of testing ceramic coatings by scratching with a diamond stylus. During a test, either a constant or increasing force normal to the surface under test is applied to the stylus so as to promote adhesive and/or cohesive failure of the coating-substrate system. The test method is suitable for evaluating ceramic coatings up to a thickness of 20 μm and might also be suitable for evaluating other coating types and thicknesses.

The International Standard is intended for use in the macro (1 to 100 N) force range. The procedures may also be applicable to other force ranges. However, appropriate calibration is essential if the normal forces at which failure occurs are to be quantified.

2 Normative references

The following referenced documents are indispensable for the application of this document. For dated references, only the edition cited applies. For undated references, the latest edition of the referenced document (including any amendments) applies.

ISO 4288, *Geometric Product Specifications (GPS) — Surface texture: Profile method — Rules and procedures for the assessment of surface texture*

ISO 6508-2, *Metallic materials — Rockwell hardness test — Part 2: Verification and calibration of testing machines (scales A, B, C, D, E, F, G, H, K, N, T)*

ISO/IEC 17025, *General requirements for the competence of testing and calibration laboratories*

3 Principle

The scratch test is designed for the assessment of the mechanical integrity of coated surfaces. The test method consists of generating scratches with a stylus of defined shape (usually a diamond with a Rockwell C geometry) by drawing it across the surface of the coating-substrate system to be tested, either under a constant or progressive normal force (see Figure 1). Failure events are detected by direct microscopic observation of the scratch and sometimes by using acoustic emission and/or friction force measurement.

The driving forces for the failure of the coating-substrate system in the scratch test are a combination of elastic-plastic indentation stresses, frictional stresses and the residual internal stress present in the coating. The normal force at which failure occurs is called the critical normal force L_c .

NOTE 1 The term "critical load" is frequently used in place of "critical normal force". The use of the term "critical load" is deprecated because the failure is typically initiated by the application of a force rather than a load.

NOTE 2 In a scratch, a number of consecutive coating-failure events may be observed at increasing critical normal-force values. Failure by cracking through the coating thickness (through-thickness cracking) usually occurs at lower normal forces than detachment of the coating. Therefore, it is quite common to characterize the onset of cracking by the critical normal force L_{c1} , while the onset of coating detachment defines the critical normal force L_{c2} . In general, a series of failure modes are observed and used to study the mechanical behaviour of the coated surface, where the onset of the n th failure mode defines the critical normal force L_{cn} (see Figure 2).

NOTE 3 The critical normal forces at which the failure events appear depend not only on the coating adhesion strength but also on other parameters, such as rate of increase of normal force, traverse speed, diamond-tip wear, substrate and coating roughness, some of which are directly related to the test itself, while others are related to the coating-substrate system.

4 Apparatus and materials

4.1 Scratch tester

A scratch tester is an instrument used to rigidly hold the stylus and to apply both the normal force and the driving force to produce scratches. A schematic of a typical arrangement is shown in Figure 3.

NOTE 1 In general, spring-deformation-controlled normal-force instruments are used in which the deformation of a spring is used to achieve the chosen force programme. Magnetically driven assemblies are also available.

Where required, the scratch tester can be equipped with acoustic emission (AE) and/or friction force (FF) transducers.

NOTE 2 Although it is attractive to use such methods for the on-line automatic quality control of coated parts, these techniques cannot discriminate between cohesive and adhesive failures, nor do they always detect the first occurrence of failure. Hence, AE and FF signals cannot be used as a reliable means for determining scratch-test critical normal forces. These techniques can at best be used as a warning system in the quality control of coated components, and then only after a large series of experiments on the same coating type to establish the statistics of correlation with a certain failure mode. Inspection of the scratch track by microscopic observation remains the only reliable means of associating a failure event with a measured critical normal force.

To meet the requirements of this International Standard, scratch testers shall comply with the calibration requirements of Annex A.

4.2 Diamond stylus

This consists of a rigidly mounted diamond normally having a Rockwell C geometry in accordance with the requirements of ISO 6508-2.

The stylus shall be inspected regularly to check for contamination and changes in geometry. If damage is observed at 200 \times or lower magnification then the stylus shall be changed (see Reference [1]), and if either damage or contamination is observed, the test results since the last inspection shall be disregarded. If the friction force increases at a constant normal force during operation, this is a presumption of contamination of the stylus.

NOTE 1 Uncertainties in the Rockwell C stylus tip shape and manufacturing defects are a major source of error for the scratch test method. The use of an imperfect stylus may result in different values of critical normal force when the stylus is rotated in its holder. Control of the stylus shape is imperative, in the as-received condition as well as during usage, to detect wear at the tip. Wear usually occurs in the form of ring cracks or crater wear, which are easily visible under a reflected-light microscope (magnification > 100 \times).

NOTE 2 A certified reference material (BCR-692) has been developed and is available from the Institute of Reference Materials and Measurements, European Commission Joint Research Centre, Retieseweg, B-2440 Geel, Belgium (www.irmm.jrc.be)¹⁾. This material, a diamond-like carbon coated substrate, presents three repeatable failure events at known critical normal-force intervals, and is available for verification purposes. This can provide a good indication of overall performance, including stylus condition and calibration.

5 Preparation of test piece

5.1 General requirements

A representative specimen of the product to be tested shall be used.

Substrate, interface and coating shall be as homogeneous as possible with respect to composition, microstructure, density, residual stress and thickness along the entire scratch length (test zone).

5.2 Surface roughness, waviness and levelling

The surface of the specimen shall have a uniform statistical roughness. The surface roughness R_a , measured according to the procedures specified in ISO 4288, shall not exceed $0,5 \mu\text{m}$.

NOTE 1 For spring-deformation-controlled normal-force instruments (typical spring constant: $0,02 \text{ N}/\mu\text{m}$), the normal force depends on the roughness and waviness of the surface. A surface roughness value R_a of $0,5 \mu\text{m}$ may lead to normal-force oscillations of $0,1 \text{ N}$. Normal-force variations of less than 1 N (1% of the typical force range) require a waviness and/or levelling error smaller than $50 \mu\text{m}$.

NOTE 2 In general, the critical force is reduced with increasing surface roughness by the concentration of stresses at roughness peaks, as well as by the poorer cleanliness properties of rough substrates prior to coating.

The test surface shall be levelled with respect to the stylus/specimen traverse-displacement direction, see Annex A. In practice, this is easily attained for flat specimens held on the sample holder. Cylindrical specimens require additional alignment facilities.

The specimen-levelling mechanism should be stiff to preclude the variation of rate of change of normal force due to the compliance of the specimen support. It has been shown that the rate of change of normal force may vary considerably with the rotational position of the spring, and the compliance of the test specimen. Ideally, mechanisms with *in situ* control of the normal force should be used.

5.3 Specimen cleaning

The specimen surface shall be freed from surface contaminants, such as oil, grease and moisture by cleaning it prior to testing.

The following cleaning procedure is adequate if no anomalous contamination has occurred: place in an ultrasonic bath for 5 min in clean analytical-grade petroleum ether. Allow to reach room temperature before testing. If drying stains are observed, wipe with a soft tissue soaked in petroleum ether. Allow at least 3 min equilibration time before testing.

During testing, the specimen surface and stylus tip shall be kept free of fingerprints.

1) This information is given for the convenience of users of this International Standard and does not constitute an endorsement by ISO of this product.

5.4 Coating-substrate parameters relevant to a test

The coating-substrate parameters relevant to a test include:

- a) substrate hardness and roughness;
- b) coating hardness and roughness;
- c) coating thickness;
- d) friction coefficient between coating and indenter;
- e) internal stress in the coating.

Where a direct comparison is to be made between the test results for two or more samples of the same coating/substrate combination, all of the above parameters shall be the same for each sample.

6 Test procedure

6.1 General

Three modes of scratch testing are currently employed, depending on the apparatus available and the information sought. In the progressive-force scratch test (PFST) mode, the normal force applied by the indenter increases linearly as the indenter moves across the test surface at constant speed. In the constant-force scratch test (CFST) mode, the normal force is increased step by step between successive scratches carried out under constant normal force, at different locations on the specimen surface until failure occurs. In the multi-pass scratch test (MPST) mode, the specimen is subjected to repeated scratching, within the same scratch track, under a constant sub-critical normal force.

NOTE 1 In general, the PFST mode is used as a first-order assessment of critical forces corresponding to major coating damage and failure, while the CFST mode allows the statistical damage analysis of coatings along their surface. The MPST mode subjects the coated surface to a low-cycle fatigue-type contact, which is considered to better simulate real working conditions of most coated components.

NOTE 2 In most cases, the CFST mode allows better discrimination between better or poorer adhesion properties than does the standard PFST method. With the current state-of-the-art equipment, however, the CFST mode is very time- and effort-consuming. The MPST mode has been shown to better rank brittle coatings in terms of their adhesion properties. The current experimental effort required, however, is even higher than in the CFST mode (see Reference [2]).

NOTE 3 There is a trend towards the extension and automation of scratch-test operation modes to facilitate the use of more advanced test regimes (see Reference [3]).

6.2 Equipment preparation

The following actions shall be taken prior to testing.

- 1) The scratch tester shall be confirmed to be calibrated in accordance with normative Annex A.
- 2) The diamond stylus shall be confirmed to be free from surface contaminants (oil, grease, material picked up from the preceding test).

If necessary, the stylus can be cleaned by wiping with a soft tissue soaked in petroleum ether. If adhering debris is still observed under an optical microscope (recommended magnification: 200×), #1200 and #2400 SiC paper can be used, followed by wiping with a soft tissue soaked in petroleum ether. Ultrasonic cleaning of the stylus should not be used as cavitation damage can occur.

Following cleaning, the stylus shall be allowed to reach room temperature before testing.

6.3 Environmental conditions

Scratch testing requires frictional interaction between the indenter and the specimen surface, and the frictional properties may be sensitive to environmental conditions. Temperature and relative humidity of the test environment shall therefore be known and controlled, if possible, to ensure repeatability.

The recommended environmental conditions are

temperature: $22\text{ °C} \pm 2\text{ °C}$,

relative humidity: $50\% \pm 10\%$.

6.4 Scratching procedure

6.4.1 General

Select the test mode that will provide the information sought, see 6.1.

NOTE It may be necessary to use more than one test mode, depending upon the coating type, the coating substrate combination and the failure mode of interest.

6.4.2 Progressive-force scratch test

Hold the specimen rigidly in the sample holder and bring the stylus into contact with the coated surface. Apply the required start force to the stylus. Select the rate of increase of normal force and table traverse speed. Values of 100 N/min and 10 mm/min are recommended. Scratch the sample and determine the critical normal forces of the selected failure events, as described in 6.5.

Preliminary scratches should be used to define a minimum start force producing an indentation that can be observed by microscope observation (see 6.5.2), and the highest critical normal force of interest. The maximum normal force used in subsequent scratches can then be limited to prevent unnecessary wear of the scratch stylus.

If the critical normal force defining the failure event of interest is lower than 10 N, a rate of increase of normal force of 10 N/min and an indenter traverse speed of 10 mm/min are recommended.

6.4.3 Constant-force scratch test

Hold the specimen rigidly in the sample holder and bring the diamond stylus into contact with the coated surface. If the equipment is able to operate in the PFST mode, scratch the surface using the procedure in 6.4.2 to determine the normal-force range of interest. Move the sample so that a new, unscratched, region can be tested. Using one-fifth of the critical normal force determined by the PFST test, produce a series of scratches at increasing normal force using an indenter traverse speed of 10 mm/min and a scratch length of 10 mm. Following evaluation of the scratches produced, a new series of scratches using lower normal-force increments can be used to investigate any regions of interest more closely.

6.4.4 Multi-pass scratch test

Hold the specimen rigidly in the sample holder and bring the diamond stylus into contact with the coated surface. Using the PFST mode, scratch the surface to determine an approximate normal force at which the failure mode of interest occurs. Using a normal force of 50 % of that determined under the PFST mode, an indenter traverse speed of 10 mm/min and a scratch length of at least 3 mm, test the sample using the MPST mode until failure occurs.

NOTE Depending on the mechanical response of the specimen under investigation, it can be necessary to adjust the normal force, lowering it to obtain better discriminating capacity, or increasing it to obtain the results in an acceptable time-scale.

6.5 Scratch evaluation and critical normal-force determination

6.5.1 General

Several different methods are in use for evaluating scratches and for the determination of critical normal forces, but only microscope observation of the scratch is able to reliably differentiate between different failure modes and enable L_c values to be attributed to specific modes of failure.

NOTE To assist users of the scratch test in the standardized reporting of scratch test results, an atlas of scratch-test failure modes is included in Annex B. The major failure events have been classified in terms of plastic deformation, cracking (L_{c1}), spallation (where the coating flakes off, typically at the edges) (L_{c2}), and penetration of the coating to the substrate at the centre of the track (L_{c3}).

6.5.2 Microscope observation

Observe the scratch or scratches produced using a reflected-light microscope. Remove loosely adhering debris if it obscures the region of interest. Select the failure of interest and either make a sketch or take a micrograph for inclusion in the test report. Alternatively, reference may be made to a representative picture in Annex B. For scratches produced using the PLST mode, determine the critical normal force for the chosen failure event by measuring the distance along the axis of the scratch from the start (trailing edge) of the scratch to the point of failure extended perpendicular to the axis, see Figure 2, and multiplying the result by the rate of change of normal force, in newtons per millimetre, determined from the time rate of change of this force and the sample displacement velocity.

Care shall be taken when removing loosely adhered debris to cause no further damage, by the use of, for example, dry air or a clean, soft, paintbrush.

NOTE 1 It is normal to ignore isolated failures, and critical normal-force values generally refer to the normal force on the stylus at the start of clustered events, see Figure 2.

NOTE 2 The recommended magnification for optical observation is between 100× and 500×.

NOTE 3 More advanced observation tools, such as scanning electron microscopy (SEM) with energy dispersive analysis (EDX), SEM operating in the backscattered mode, scanning profilometry or a scanning acoustic microscope can be used to evaluate the coating damage more accurately. Scanning acoustic microscopy and scanning profilometry enable the detection of delamination events below the surface of the coating (blister formation).

6.5.3 Acoustic emission (AE) and frictional force (FF) recording

Failure events under the scratch stylus, during scratching, may result in perturbations of *in situ* monitored AE and FF signals (see Figure 4). If such monitoring is used, record the normal forces at which perturbations occur, so that these may be related to failure events observed during the microscope examination of the scratches.

Acoustic emission is generated by the elastic waves resulting from the energy released by the creation and propagation of cracks, but it can also be related to friction phenomena and instrumental noise (e.g. from the friction table). The operator may select a detection limit sensitivity to adjust the AE-recording to the agreed failure criterion. The AE-sensor should be of the resonant type, and the electronics should have a 30 kHz high pass filter (without energy integration) to avoid the mechanical vibration frequencies of the instruments (typically from 0 kHz to about 30 kHz).

NOTE *In situ* measurement of the specimen displacement is desirable, to enable the direct correlation between normal force, displacement, and other measuring signals.

7 Repeatability and limits

Because of the statistical nature of the failure probability, an exact critical normal-force value obtained in a single measurement is not significant, and at least five test operations shall be carried out. Consecutive test operations shall be performed in such a way that the critical normal forces cannot be influenced by the preceding scratch tracks.

Accepted limits for scratch testing are:

- a) critical normal force $L_c > 1 \text{ N}$;
- b) resolution of normal force: $0,1 \text{ N}$;
- c) coating thickness $< 20 \text{ }\mu\text{m}$;
- d) roughness parameter $R_a < 0,5 \text{ }\mu\text{m}$.

NOTE The typical measurement uncertainty at the 95 % confidence level is 20 %, and different operators introduce errors in the range 5 to 10 %. Under optimum conditions, the reproducibility between instruments used for the scratch test is better than 15 % (see Reference [4]).

8 Test report

The test report shall include the following information:

- a) the name of the testing establishment;
- b) the date of the test, a unique identification of the report and of each page;
- c) the name and address of the customer, and a signatory of the report;
- d) a reference to this International Standard, i.e. "Determined in accordance with ISO 20502";
- e) the identification of the test material or product;
- f) the procedure used for specimen preparation;
- g) sample planarity;
- h) rate of application of normal force;
- i) traverse speed;
- j) indenter tip radius;
- k) environmental conditions;
- l) test results for L_{cn} ;
- m) a description of the failure modes by reference to a micrograph, sketch or appropriate figure in Annex B;
- n) dates of last calibration of instrument and indenter;
- o) comments on the test or test results, which shall be reported in accordance with ISO/IEC 17025;
- p) cycles to failure if tested in the MPST mode.

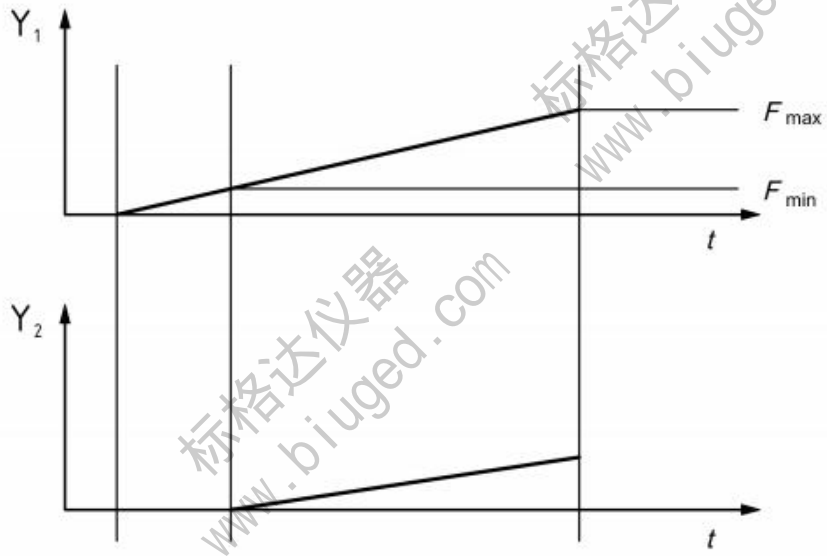

a) Progressive force operation mode

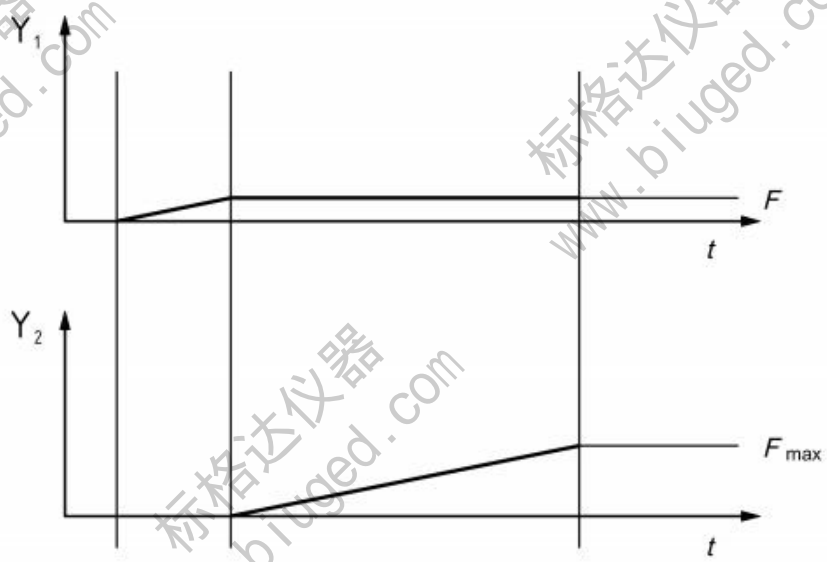

b) Constant-force operation mode

- Key**
- t time
 - Y_1 normal force
 - Y_2 indenter traverse distance
 - F_{max} maximum force
 - F_{min} minimum force

Figure 1 — Sketches illustrating the normal force and traverse distance versus time

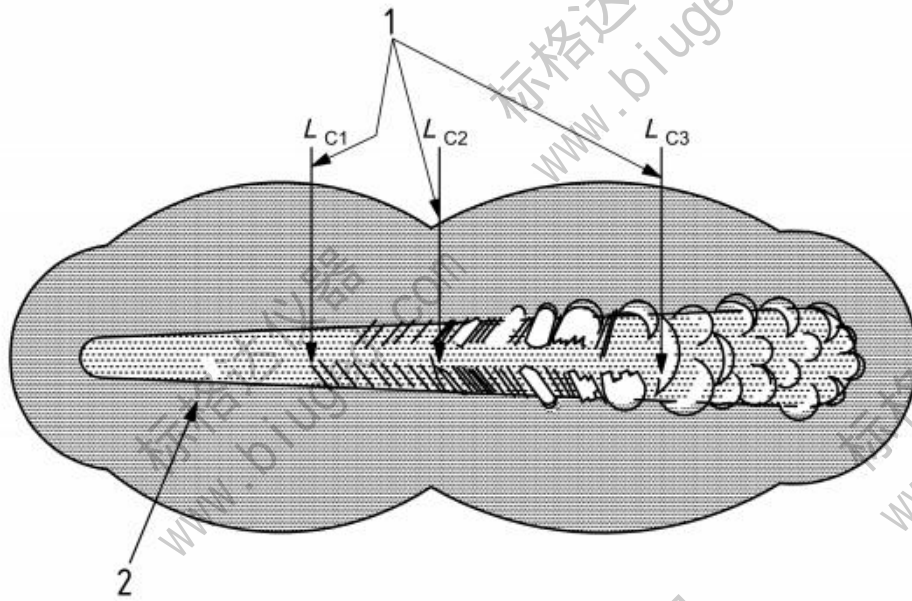

Key

- 1 critical normal forces indicating start of clustered events
- 2 isolated event

Figure 2 — Schematic representation of isolated and clustered events

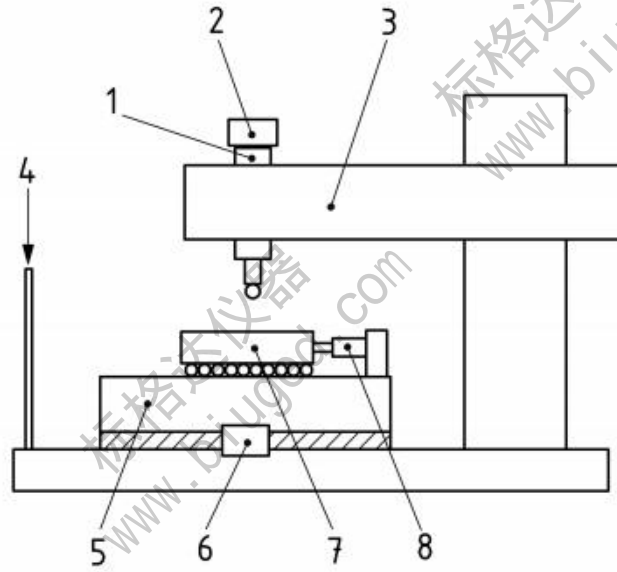

Key

- 1 stylus shaft
- 2 vertical force transducer
- 3 upper-support assembly
- 4 base reference
- 5 XY stage to manoeuvre samples
- 6 XY stage drive arrangement
- 7 low-friction sample table
- 8 horizontal force transducer

Figure 3 — Schematic of a typical scratch tester

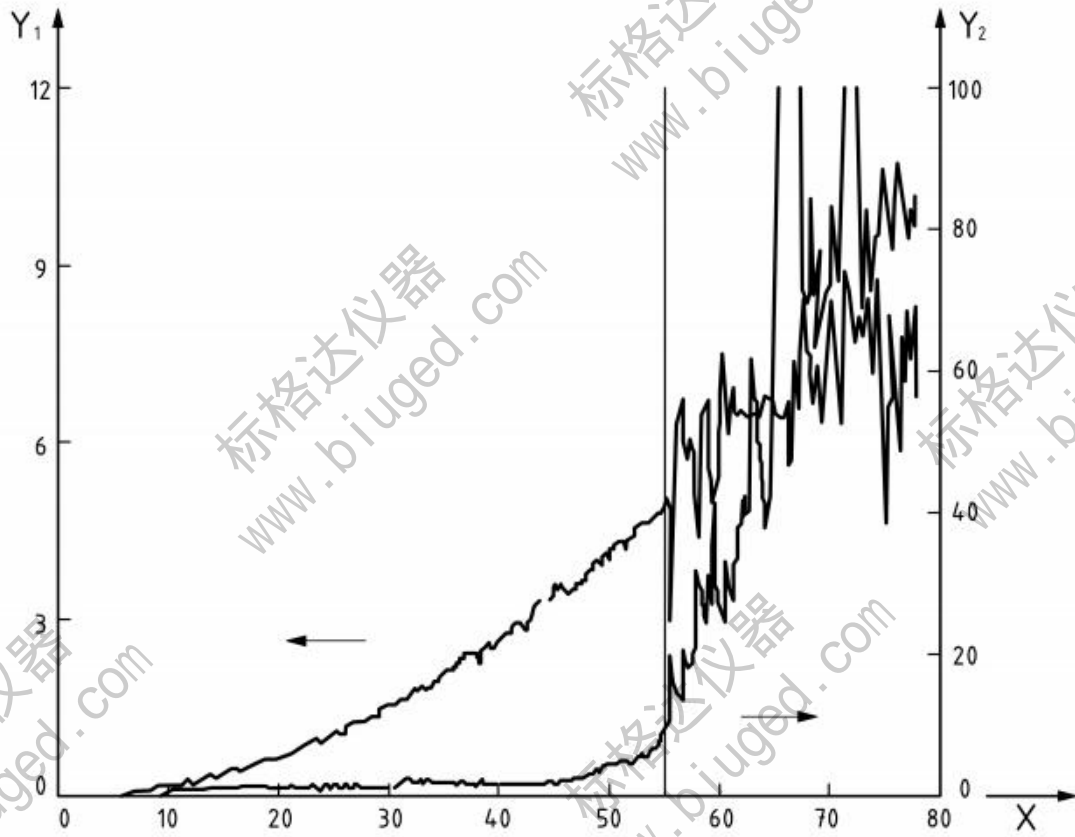

Key

- X normal force (N)
- Y₁ friction force (N)
- Y₂ acoustic emission (arbitrary units)

Figure 4 — Acoustic emission and friction force recording versus normal force

Annex A (normative)

Procedure for calibration of a scratch testing system

A.1 Introduction

It is essential to ensure that force and displacement measurements that are made with scratch test instruments are correct if relevant values for critical normal forces are to be quoted. This annex describes procedures for mandatory calibrations of scratch test instruments.

The procedures described were developed as part of the FASTE programme (see Reference [1]) on the development and validation of test methods for thin hard coatings, which was supported by EC contract MAT1-CT-940045. Procedures are given for calibrating horizontal displacement, applied normal force and frictional force measurements, together with a procedure to ensure that the test surface moves in a direction orthogonal to that of the stylus.

The procedures described were used by the participants in the FASTE exercise (Task S) to quantify the behaviour of their test systems, and formed the basis for analysis of the results of an inter-laboratory comparison which was an important element of the FASTE exercise.

NOTE If carefully performed, the accuracy of calibration is better than 1 %.

A.2 Scope

This annex describes procedures for the following mandatory calibrations:

- a) calibration of the motion of the test surface relative to the stationary stylus;
- b) calibration of the force transducer which measures applied normal force;
- c) calibration of the measurement of horizontal displacement of the indenter across the sample;
- d) calibration of the force transducer which measures frictional force (where fitted).

A.3 Principle

With the exception of sample flatness calibration, the procedures described compare the outputs of instrumental transducers to those from traceably calibrated measuring instruments; when measuring the same parameters under identical conditions.

A.4 Apparatus

A.4.1 Introduction

In order to conduct the calibration procedures, additional items of apparatus are required. Those items that are involved with providing data for the calibration i.e. force transducers, displacement devices, etc. shall themselves be traceably calibrated to national standards.

Devices for recording outputs of transducers are an absolute requirement of the procedures. The minimum that can be considered is a two-channel XY chart recorder. Ideally, an AID card installed into a personal computer provides the best solution, as subsequent data processing can be automated and the introduction of processing errors reduced. Again, these devices shall be traceably calibrated to national standards.

Two of the procedures, namely normal-force application and horizontal displacement, specify that a 'rate' of application be achieved. This implies that a time base is recorded and, therefore, calibration of time shall be provided for.

The lists in A.4.2 to A.4.4 give the ancillary equipment and/or samples required to perform each individual procedure.

A.4.2 Normal force

- a) A force transducer with sufficient range (normally 0 N to 100 N will be sufficient) and dimensions to fit between the stylus and sample holding plate.
- b) A hardened steel plate to be located on the surface of the force transducer contacted by the stylus. This is for protection purposes.

A.4.3 Horizontal displacement

- a) A long-stroke displacement transducer (range >10 mm with a resolution of 5 μm) and a means of attachment to the sample stage.
- b) A travelling microscope to measure the length of the scratches.

A.4.4 Frictional force

- a) A force transducer with sufficient range (normally 0 N to 100 N will be sufficient).
- b) Dimensions to fit onto the sample holding plate.
- c) A hardened steel plate for the force transducer to work against.
- d) Attachments to provide horizontal force into the sample stage.
- e) A roller-supported system should be considered.
- f) Alternatively, a pulley arrangement with freely suspended weights can be used.

A.5 Calibration procedures

A.5.1 Procedure 1: assessment of orthogonality of motions of indenter and test surface

A.5.1.1 Mount the sample to be tested on the sample table and perform a scratch test at a constant normal force of 10 N, at a rate of 10 mm/min and with a length of 10 mm.

A.5.1.2 The test surface can be considered to be level if the greatest deviation from the recorded normal force is no greater than $\pm 0,5$ N. If the test surface does not meet the requirements then appropriate adjustments shall be made until conformance is achieved.

A.5.1.3 Alternatively, if an optical microscope can be used to view the sample stage or mounted sample in its testing position then, provided that they remain in focus for the length of the scratch, they can be considered as suitably levelled. In order to reduce the effects of depth of field produced by the optics, a magnification of no lower than 200 \times shall be used.

A.5.2 Procedure 2: normal force

A.5.2.1 Place the calibrated-force transducer on the sample stage and mount a hardened steel plate on top, such that the indenter will apply an axial force to the force transducer, see Figure A.1.

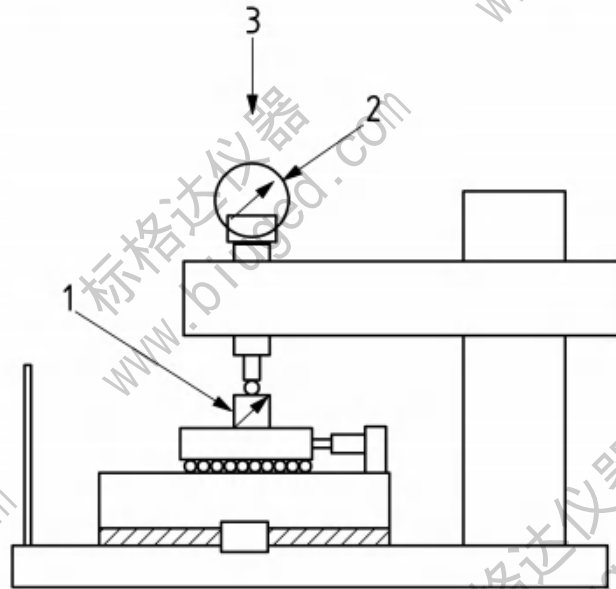

- Key**
- 1 calibrated-force transducer
 - 2 instrument force transducer
 - 3 force application

Figure A.1 — Experimental arrangement for calibration of normal force

A.5.2.2 Using the normal-force application mechanism of the scratch tester, incrementally increase the applied normal force and record the output of the calibrated-force transducer as a function of the scratch-tester force transducer. A minimum of 20 increments shall be obtained up to the maximum applied normal force (typically 100 N) of the scratch tester.

NOTE Readings can be made with a chart recorder, digital voltmeter or computer-based digital acquisition system.

A.5.2.3 Repeat this test cycle four times and discard the first set of measurements.

A.5.2.4 Convert the values for the output from the calibrated-force transducer into known applied normal forces (N) and perform a least-squares linear regression on the data, and record the slope of the normal-force curve (L_{NS}) and force offset calibration (L_{NO}) coefficient.

In this analysis, the output from the scratch-tester applied force transducer (V_N) should be treated as the independent variable and the known normal force (F_n) as the dependent variable, so that the linear regression analysis fits the data to an expression of the form;

$$F_n = L_{NS}V_N + L_{NO}$$

A.5.2.5 A continuous normal-force application cycle (up to a maximum normal force of 100 N) shall also be performed and plotted against a time base, using the stylus and sample for testing. This will calibrate the force application rate. The force application rate (L_{NR}) is equal to the slope of the normal-force-time graph. The application rate of the normal force should be adjusted until it is $(100 \pm 1) \text{ N min}^{-1}$.

On some designs of scratch tester, the positioning of the normal-force transmitting spring located at the end of the cantilever arm can adversely affect the application rate of the normal force, especially during the early stages of a test. Care should be taken to ensure that this spring is correctly located.

A.5.3 Procedure 3: horizontal displacement

A.5.3.1 Clamp the calibrated displacement transducers firmly to the scratch-tester horizontal displacement transducer so that the two transducers are in parallel. Use the normal motion mechanism to incrementally move the specimen stage over the full measurement range of the displacement transducer, see Figure A.2.

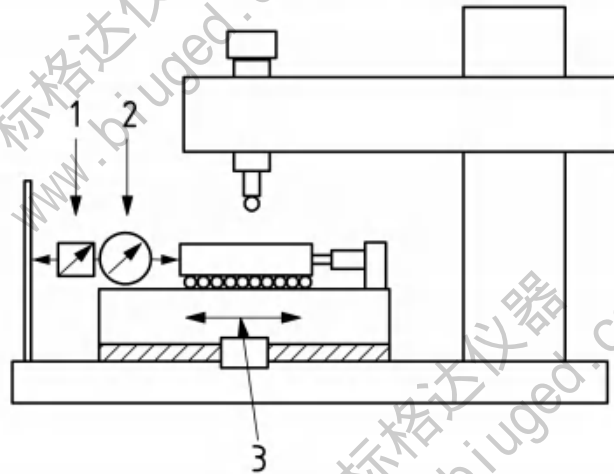

Key

- 1 calibrated displacement transducer
- 2 instrument displacement transducer
- 3 direction of motion

Figure A.2 — Experimental arrangement for calibration of horizontal displacement

A.5.3.2 Record the output from the calibrated displacement transducer as a function of the output of the in-built horizontal displacement transducer. A minimum of 20 increments of displacement to the maximum setting shall be made.

NOTE Readings can be made with a chart recorder, digital voltmeter or computer-based digital acquisition system.

A.5.3.3 Repeat this test cycle four times and discard the first set of measurements.

A.5.3.4 Convert the values of the output from the calibrated displacement transducer into known horizontal displacements (d_H), perform a least-squares linear regression on the data, and record the horizontal-displacement scaling calibration (D_{HS}) and horizontal-displacement offset calibration (D_{HO}) coefficients.

In this analysis, the output from the scratch-tester horizontal displacement transducer (V_{dH}) should be treated as the independent variable, and the known horizontal displacement (d_H) as the dependent variable, so that the linear regression analysis fits the data to an expression of the form:

$$d_H = D_{HS}V_{dH} + D_{HO}$$

A.5.3.5 Check the alignment of the transducer relative to the stage by measuring the length of a scratch made on a steel sample, and compare this with the length calculated from the displacement transducer readings. If any discrepancies occur between the two measurements then the alignment of the transducer shall be checked.

A.5.3.6 A displacement-time graph should also be recorded to allow calibration of the horizontal displacement rate (velocity) of the stage to be made. The velocity (D_{HR}) is equal to the slope of the displacement-time graph. The velocity should be adjusted to $(10 \pm 0,1) \text{ mm min}^{-1}$.

A.5.3.7 If a second displacement transducer is not available, then the following alternative method of checking the in-built transducer can be used. Using an easily marked substrate (e.g. hardened steel or ceramic), make a series of scratches of varying length under a constant normal force of low value (e.g. 10 N). Measure the total length of the scratches less the track widths, and compare these lengths to those indicated by the in-built transducer (see Figure A.3).

NOTE This procedure can be carried out at the same time as that for sample planarity.

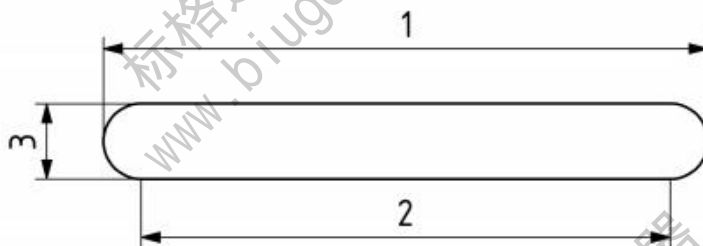

Key

- 1 total scratch length
- 2 indicated scratch length
- 3 scratch width

NOTE Scratch displacement = Total length – scratch width.

Figure A.3 — Schematic for the determination of sample displacement

A simple assessment of displacement rate can be obtained by performing a constant-force scratch (10 N), and measuring the scratch length with a travelling microscope. A time base can be derived from the normal-force trace, which should be recorded. This procedure can be carried out at the same time as that for sample planarity is being performed.

A.5.4 Procedure 4: frictional force

A.5.4.1 A mechanism (thumb-screw pushrod, pulley system or manual control of the normal drive mechanism) is required to provide a controlled application of the calibration force.

A.5.4.2 Mount the calibrated-force transducer onto the scratch tester in such a way that an axial force is applied to both the calibrated cell and the scratch tester's own force transducer, e.g. by the use of a retaining block, see Figure A.4. The calibrated transducer should be mounted so that its axial position is as close to the normal sample surface as possible and, in any event, no more than $\pm 10 \text{ mm}$ from it, see Figure A.4.

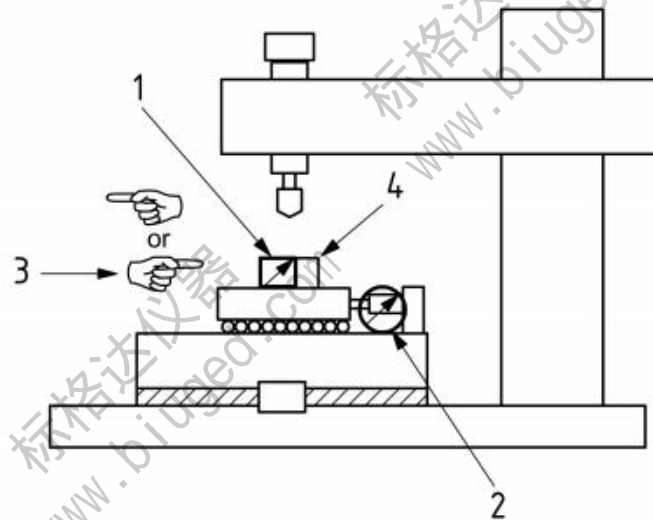
**Key**

- 1 calibrated-force transducer
- 2 instrument force transducer
- 3 force application
- 4 retaining block

Figure A.4 — Experimental arrangement for calibration of frictional force

A.5.4.3 Incrementally increase the horizontal force and take readings of the output from the calibrated-force transducer and the scratch-tester force transducer. At least 20 increments should be used, up to the maximum frictional force that is expected.

NOTE Readings can be made with a chart recorder, digital voltmeter or computer-based digital acquisition system.

A.5.4.4 Repeat this test cycle four times and discard the first set of measurements.

A.5.4.5 To detect possible measuring sensitivity of the horizontal force transducer to the relative positioning of the scratch, the calibrations should be performed with the sample stage offset by 10 mm to the left and right of the centre-line of the friction force transducer.

A.5.4.6 Convert the values of the output from the calibrated-force transducer into known simulated frictional forces (F) and perform a least-squares linear regression on the rest of the data, and record the frictional force scaling calibration (L_{FS}) and frictional force offset calibration (L_{FO}) coefficients.

In this analysis, the output from the scratch-tester applied force transducer (V_F) should be treated as the independent variable and the known normal simulated frictional force (F) as the dependent variable so that the linear regression analysis fits the data to an expression of the form:

$$F = L_{FS}V_F + L_{FO}$$

A.6 Recording results

The results of the above calibrations shall be recorded and appended to the Test Report, if required. The results to be recorded are listed in Table A.1.

Table A.1 — Calibration results

Parameter	Description
L_{NS}	Normal-Force Scaling Calibration
L_{NO}	Normal-Force Offset Calibration
L_{NR}	Normal-Force Application Rate
D_{HS}	Horizontal-Displacement Scaling Calibration
D_{HO}	Horizontal-Displacement Offset Calibration
D_{HR}	Horizontal Displacement Rate
L_{FS}	Friction-Force Scaling Calibration
L_{FO}	Friction-Force Offset Calibration

Annex B (informative)

Typical failure modes obtained in scratch testing

B.1 Introduction

In the scratch test, a stylus is drawn across the specimen surface under increasing normal force until some well-defined failure event occurs at a force which is called the critical normal force, L_c . L_c can be determined *in situ* by monitoring acoustic emission, lateral forces or the scratch depth, but these methods cannot discriminate between interfacial and cohesive failures, nor can they always detect the very first failures. Microscopic examination of the scratch track remains the only reliable means of associating a failure event with a critical normal force.

To enable the standardized reporting of scratch critical normal-force values, an atlas of scratch-test failure modes (see Reference [5]) was produced within the framework of the EC SMT project FASTE, on the development and validation of test methods for thin hard coatings.

B.2 Experimental

Traceable calibration of scratch test instruments and cleaning procedures were developed in the project, and a methodology established. Scratches were made on a series of different coating systems. Standard scratch parameters of 100 N/mm and 10 mm/min were used, and a qualified diamond Rockwell C stylus was employed, with rigorous control of the shape and cleaning prior to each test.

Under a reflected-light microscope, micrographs were taken from each observed failure mode, using magnifications of 180× and 360×.

B.3 Results

An inventory of the major scratch-test failure modes was established, which were classified into plastic deformation and different forms of cracking, spallation and coating penetration events.

Photomicrographs of the actual failures at two different magnifications are shown in Figures B.1 to B.20, together with a sketch illustrating the pertinent features of each failure and the precise event for which the critical normal force has been determined (marked by X). Each illustration is accompanied by a concise description of the failure mode as well as of the coating/substrate composition, and the critical normal-force value at which the failure event occurred.

B.4 Conclusions

The present catalogue of scratch-test failure modes cannot claim to be comprehensive, but should be regarded as a first step to the standardized reporting of scratch-test critical normal forces.

In addition, the magnitude of, and subtle changes in, the observed failure modes may, in many cases, be as important as the failure mode itself for assessing the quality of a coated specimen.

There is still much research work to be carried out in order to understand the mechanism of each failure mode.

B.5 Scratch test atlas of failure modes

In Figures B.1 to B.20:

- a) the scratch direction is from left to right;
- b) the critical normal-force values indicate when the failure event first occurred;
- c) the upper micrograph is at a magnification of 180x;
- d) the lower micrograph is at a magnification of 360x;
- e) the bottom sketch in each figure shows the point (x) representing the point at which the accompanying critical normal-force value was determined;
- f) steel designations refer to AISI standards;
- g) hardness scales: HRC = Rockwell C hardness

HB = Brinell hardness (2942 N; 10 mm ball).

SCALE MARKERS:

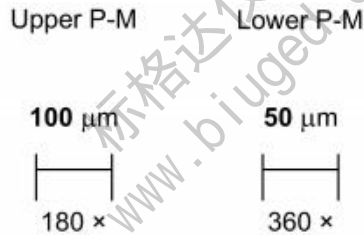

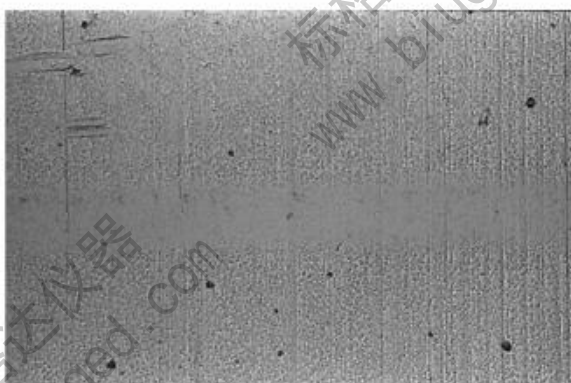
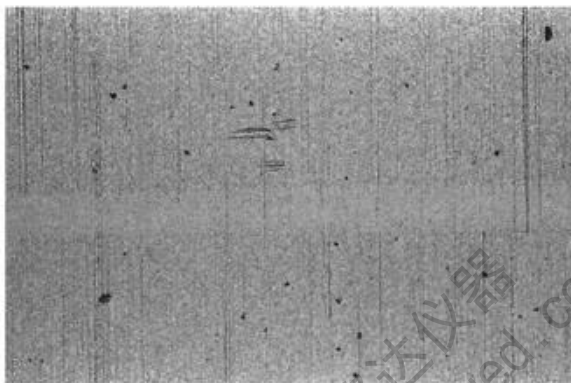

PVD TiN (3,8 μ m) on hardened and ground M2 steel (64 HRC); $L_c = 5$ N

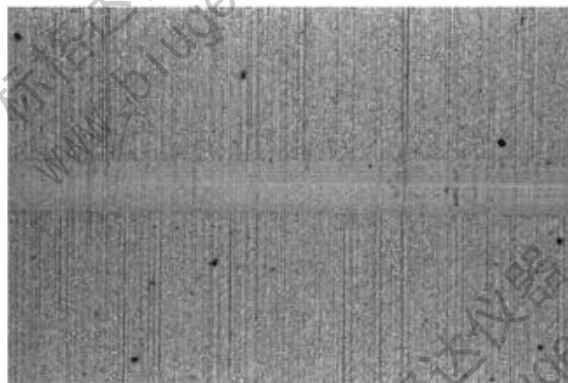

PVD TiN (3,8 μ m) on hardened and ground M2 steel (64 HRC); $L_c = 22$ N

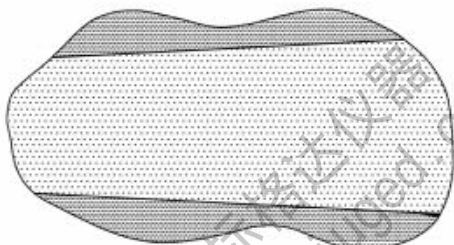

Figure B.1 — Plastic deformation

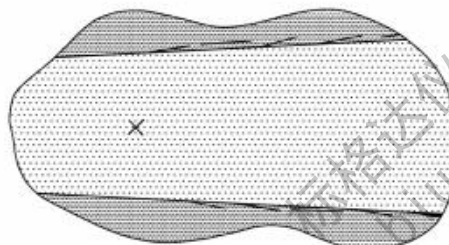
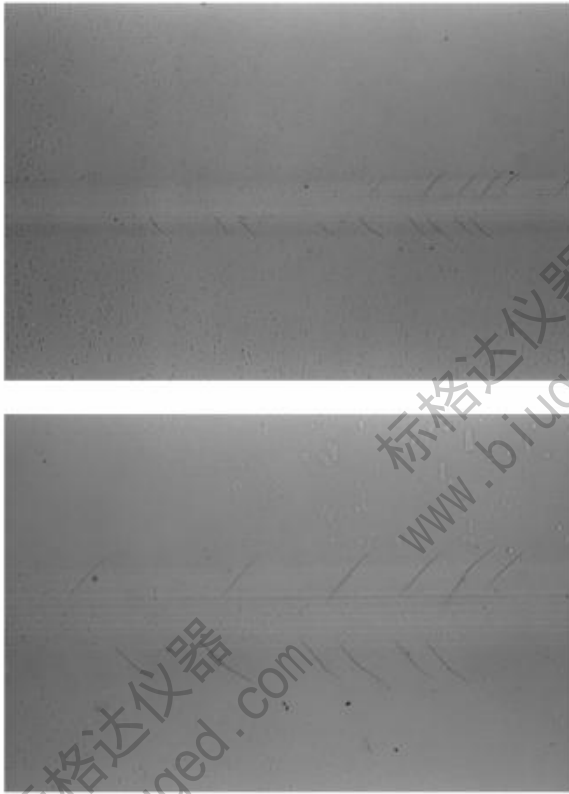

Figure B.2 — Longitudinal cracks at the borders of the scratch track



PACVD DLC (6,6 μm) on hardened and polished M2 steel (64 HRC); $L_c = 36\text{ N}$



PVD Cr - 0.5 % C (5 μm) on hardened and ground M2 steel (64 HRC); $L_c = 15\text{ N}$

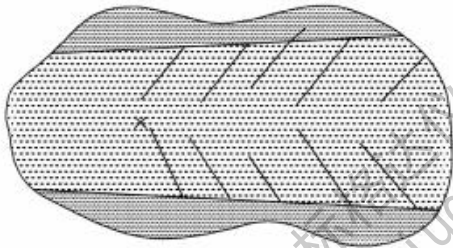

Figure B.3 — Forward chevron cracks at the borders of the scratch track

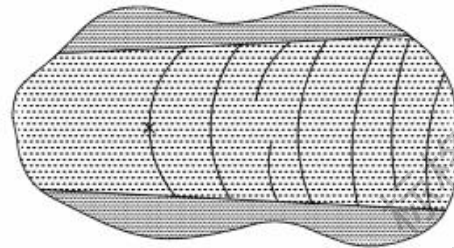
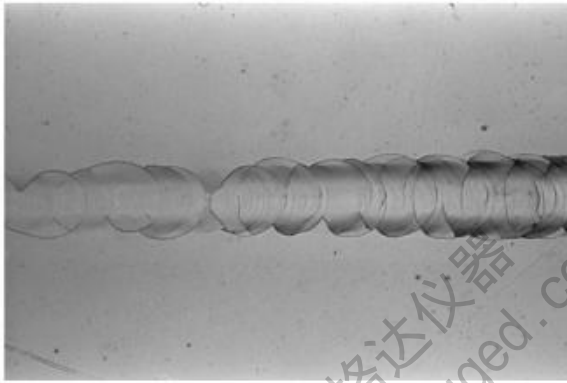
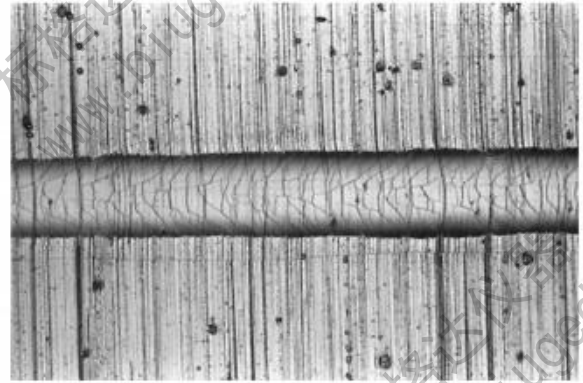
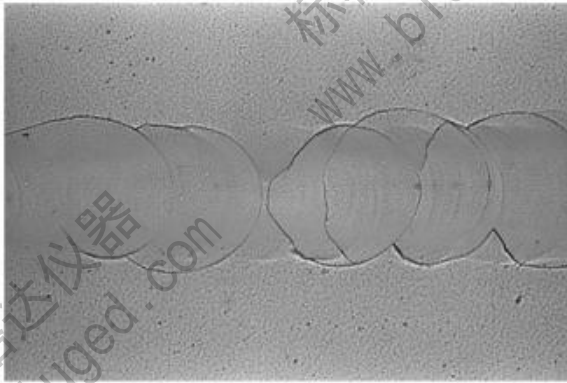

Figure B.4 — Tensile-type Hertzian cracks within the scratch track



PVD AISI 316 - 10 % N (10 μ m) on polished 316 (155 HB); $L_c = 28$ N



Electrolytic hard-Cr (7 μ m) on hardened and ground 4137/35 steel (56 HRC); $L_c = 5$ N

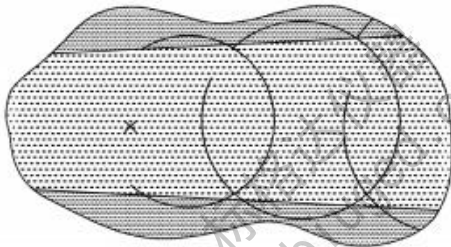
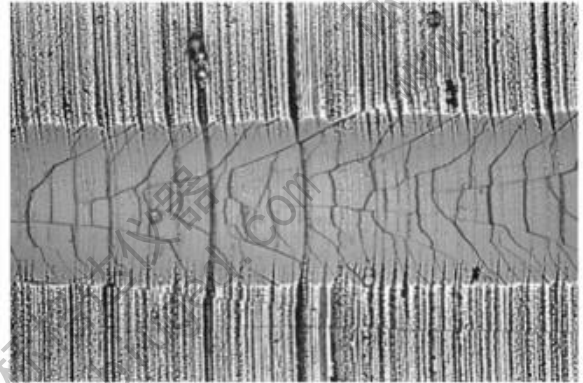

Figure B.5 — Hertzian-type circular cracks

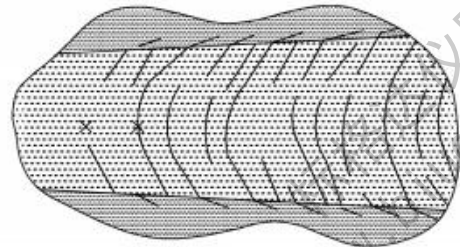
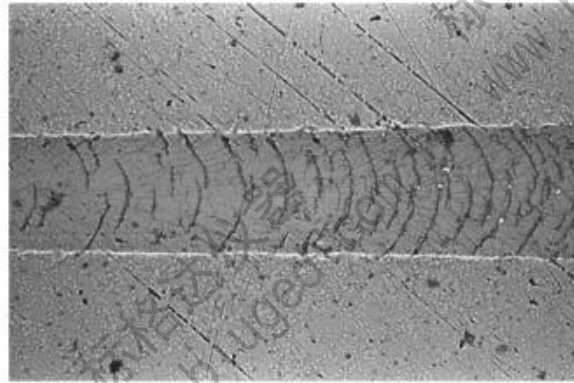
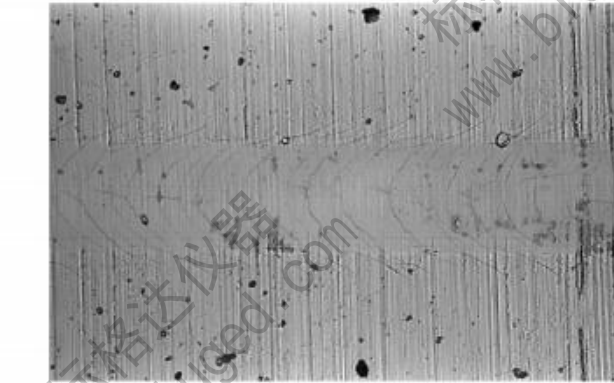
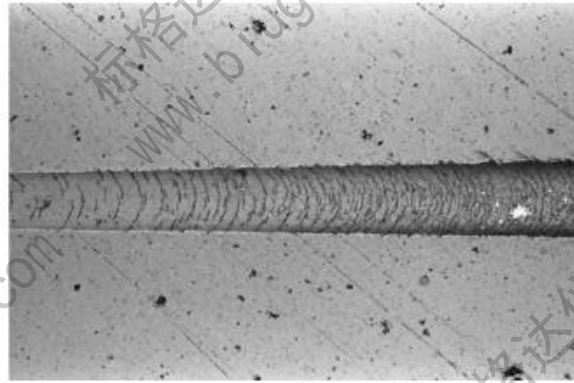
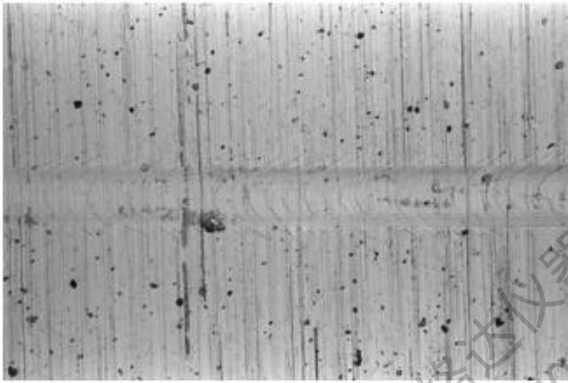

Figure B.6 — Combination of cracks as shown in Figures B.3 and B.4, within the scratch track (ignore deformation of grinding marks)



PVD Cr - 1% C (5 μ m) on hardened and ground M2 steel (64 HRC); $L_c = 11$ N

Arc-discharge DLC (0,4 μ m) on annealed and polished 440B (260 HB); $L_c = 8$ N

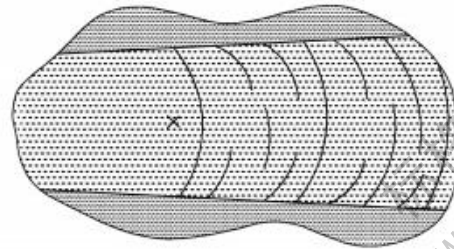
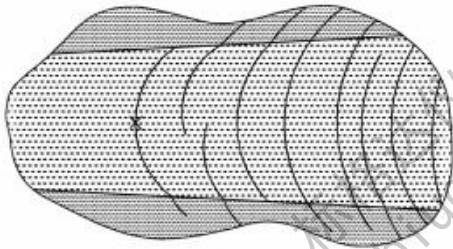
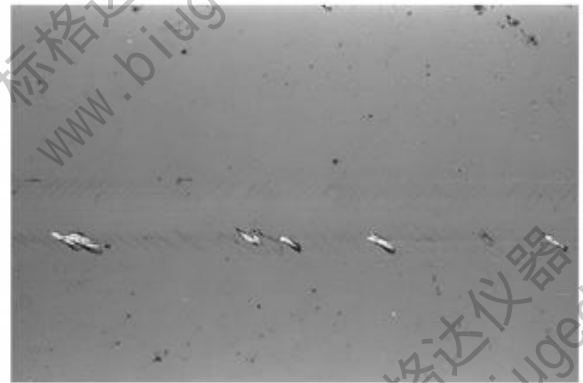

Figure B.7 — Combination of cracks as shown in Figures B.3 and B.4, extending out of the scratch track

Figure B.8 — Conformal-type buckling cracks



PVD Al₂O₃ (3,6 μm) on hardened and ground M2 steel (64 HRC); $L_c = 12$ N



PACVD DLC (2 μm) on hardened and polished M2 steel (64 HRC); $L_c = 38$ N

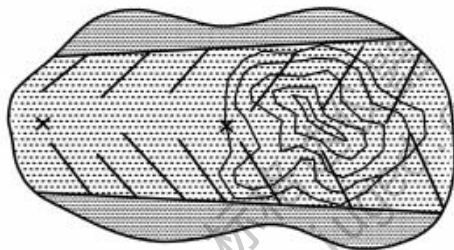
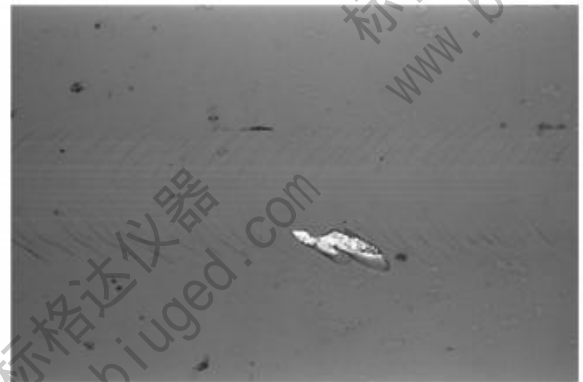
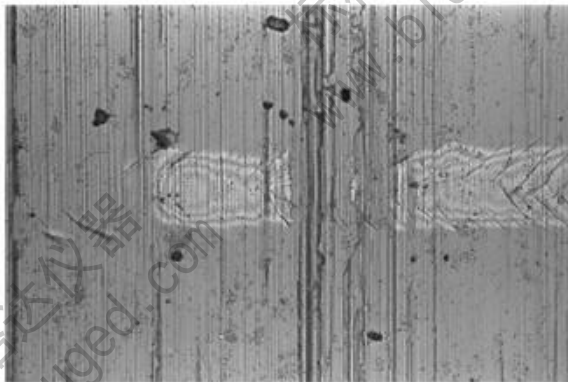

Figure B.9 — Cracks as shown in Figure B.3, with blister formation

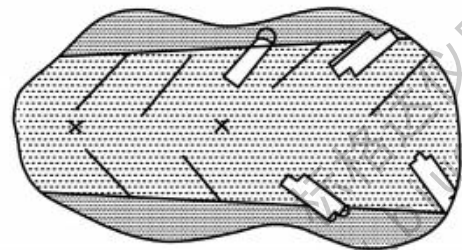
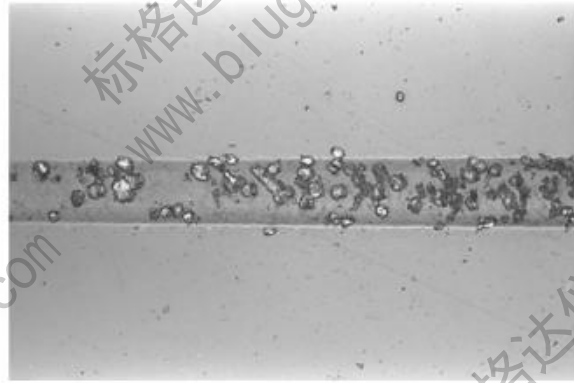
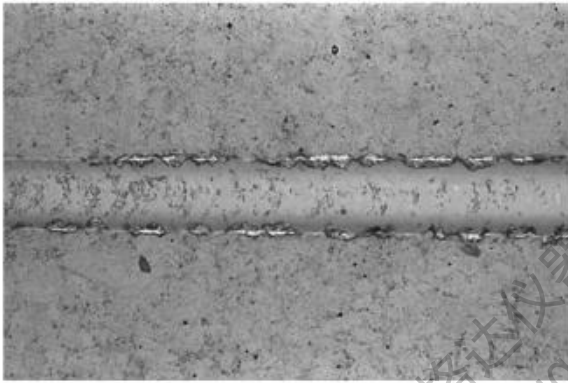

Figure B.10 — Cracks as shown in Figure B.3, with local interfacial spallation



PVD TiN (1,4 μm) on hardened and polished M2 steel (64 HRC); $L_c = 37\text{ N}$

PACVD polymer a-C:H (1,2 μm) on hardened and polished 1060 steel (61 HRC); $L_c = 25\text{ N}$

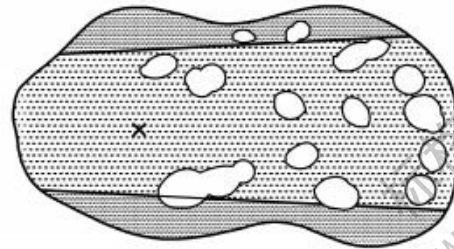
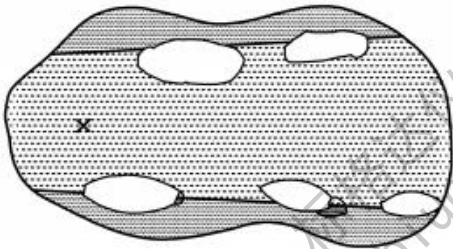
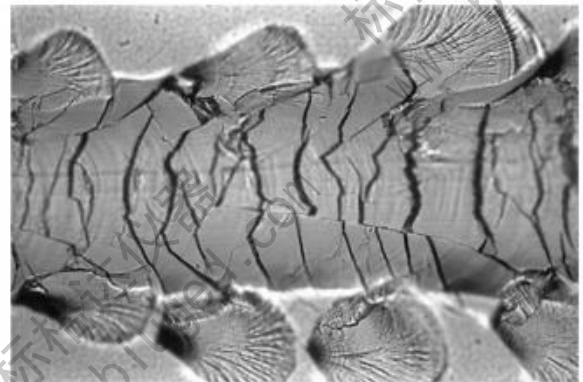
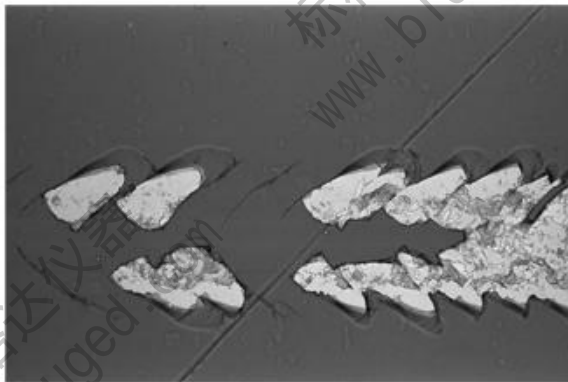
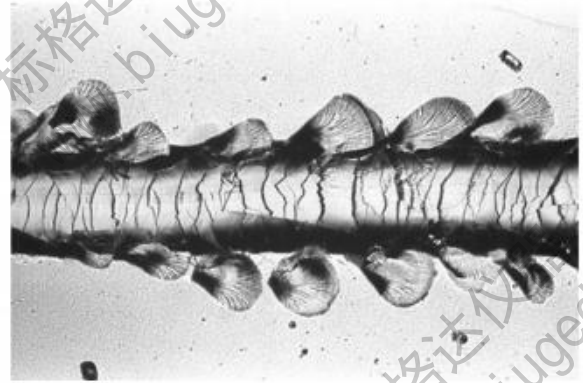

Figure B.11 — Interfacial spallation at the border of the scratch track

Figure B.12 — Local spallation inside and next to the scratch track



PACVD DLC (3,3 μm) on hardened and polished M2 steel (64 HRC); $L_c = 29$ N

PVD AISI 316 - 10% N (10 μm) on polished 316 (155 HB); $L_c = 23$ N

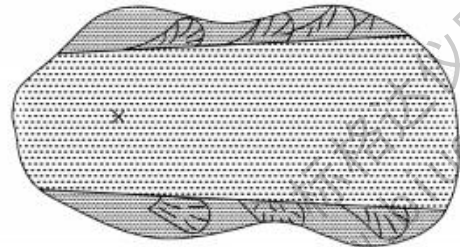
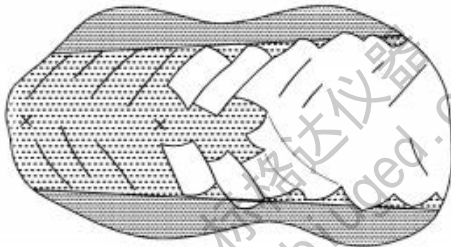
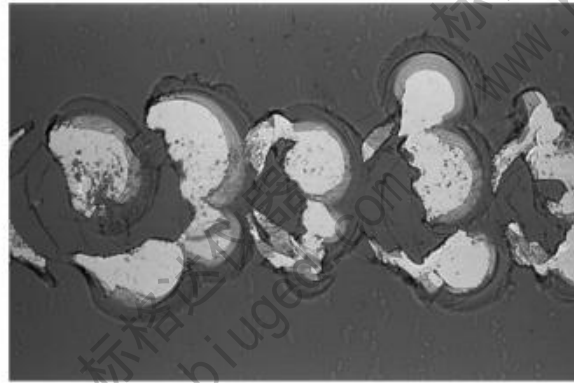
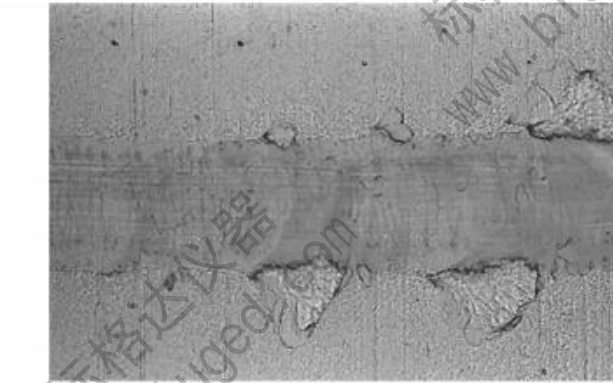
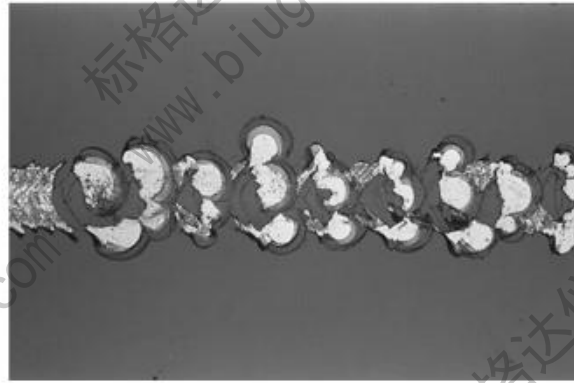
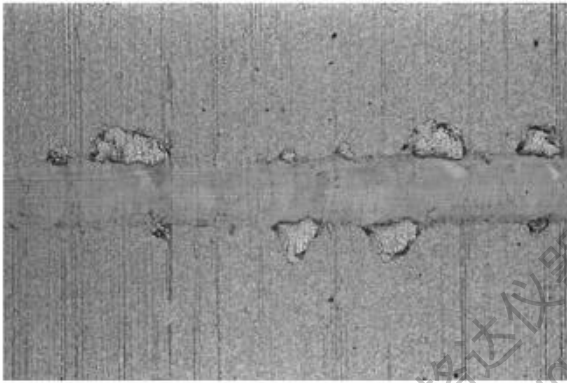

Figure B.13 — Cracks as shown in Figure B.3, with gross interfacial spallation

Figure B.14 — Cohesive spallation along the scratch-track borders



PVD TiN ($3,8 \mu\text{m}$) on hardened and ground M2 steel (64 HRC); $L_c = 42 \text{ N}$

PACVD DLC ($3,3 \mu\text{m}$) on hardened and polished M2 steel (64 HRC); $L_c = 43 \text{ N}$

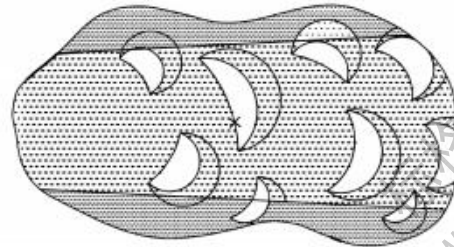
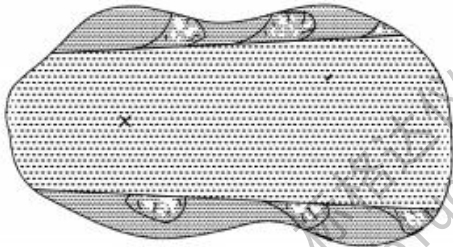
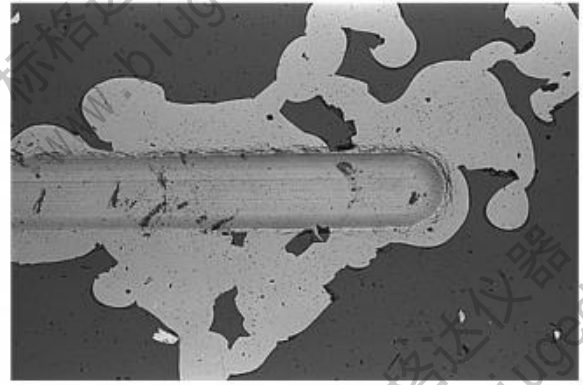
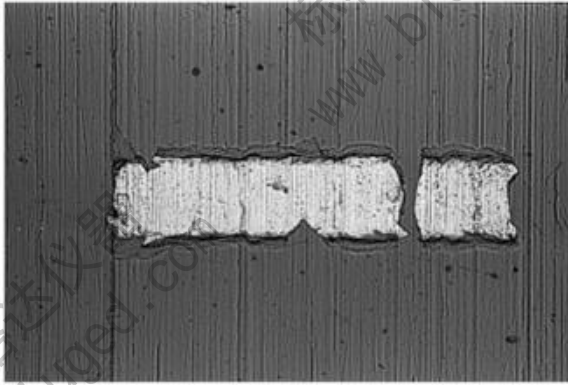

Figure B.15 — Spallation along the scratch-track borders, both cohesive and interfacial

Figure B.16 — Gross interfacial shell-shaped spallation



PACVD DLC (3,4 μm) on hardened and ground M2 steel (64 HRC); $L_c = 15$ N



PACVD DLC (2 μm) on hardened and polished M2 steel (64 HRC); $L_c = 10$ N

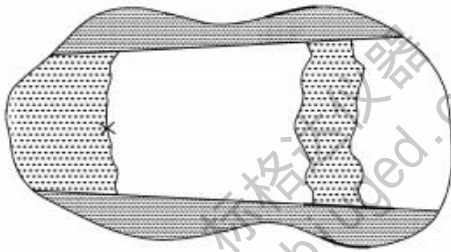
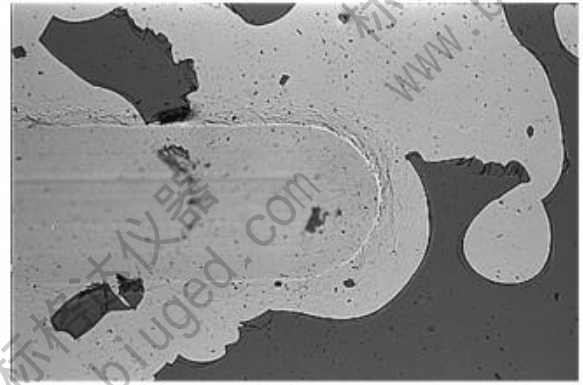

Figure B.17 — Large-scale interfacial spallation inside the scratch track

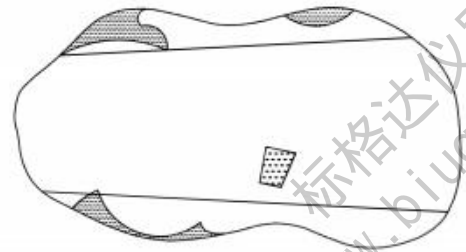
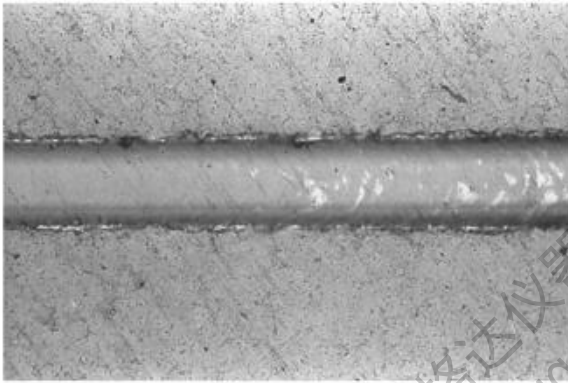
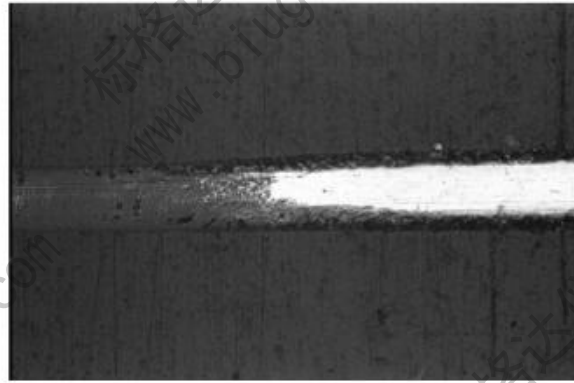

Figure B.18 — Large-area interfacial spallation



PVD TiN (1,4 μm) on hardened and polished M2 steel (64 HRC); $L_c = 45 \text{ N}$



PVD DLC (3,2 μm) on hardened and ground M2 steel (64 HRC); $L_c = 51 \text{ N}$

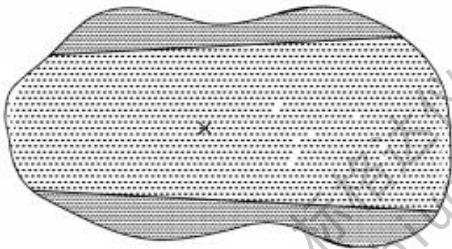
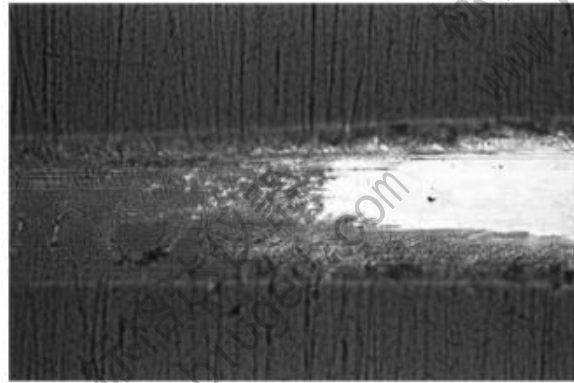
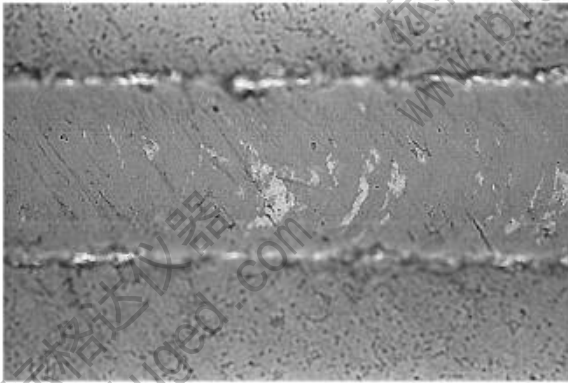

Figure B.19 — Discontinuous ductile perforation of the coating

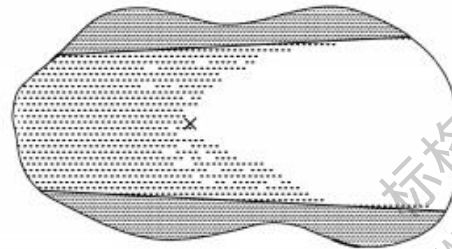

Figure B.20 — Continuous ductile perforation of the coating

Bibliography

- [1] European Commission — Measurements and Testing Programme, *Project 'Development and Validation of Test Methods for Thin Hard Coating - FASTE'* Contract MAT1-CT94/0045
- [2] Belgian Federal Office for Scientific, Technical and Cultural Affairs — Scientific Support for Standardisation Programme, *Project 'Adhesion Testing of Coated Surfaces'*, Contract No. NO/D5/018
- [3] European Commission — Standards, Measurements and Testing Programme, *Project 'Multi-Mode Scratch Testing: Extension of Operation Modes and Update of Instruments - MMST'*, Contract SMT4-CT97/2150
- [4] European Commission — Standards, Measurements and Testing Programme, *Project 'A Certified Reference Material for the Scratch Test — REMAST'*, Contract SMT4-CT98/2238
- [5] *Wall poster "Scratch Test Atlas of Failure Modes"*, developed in the FASTE project. Contact Ir. J. Meneve, Materials Technology Centre, Vlaamse Instelling voor Technologisch Onderzoek, Boeretang 200, B-2400 Mol, Belgium, Fax: + 32/14/32 11 86, E-mail: menevej@vito.be

标格达仪器
www.biuged.com

标格达仪器
www.biuged.com

标格达仪器
www.biuged.com

标格达仪器
www.biuged.com

标格达仪器
www.biuged.com

.com

标格达仪器
www.biuged.com

标格达仪器
www.biuged.com

标格达仪器
www.biuged.com

标格达仪器
www.biuged.com

ICS 81.060.30

Price based on 31 pages

标格达仪器
www.biuged.com